



Modular Design, Beyond Reliability  
**Huawei UPS Solutions**



**T**he rapid development of cloud technology is imposing ever stricter requirements on power supply – the very lifeblood for servers and switches. Ensuring reliable power supply, Huawei delivers reliable, efficient, and simple UPS to cope with the disadvantages of efficiency, expansion, and availability hindrances, as well as high maintenance costs that traditional UPS brings. Huawei UPS provides customers with the best power supply solution to help customers deal with the problems encountered on overburdened power grids.

## Huawei UPS Design Concept

### Reliable

By using state of art design and craftsmanship, Huawei UPS provides customers the comprehensive reliability assurance measures from power input, energy storage to power output, which ensures the safe operation to the end user.

### Efficient

Combining optimized circuit topology, and high quality components, Huawei's full-range of UPSs offers you the high efficiency with low heat dissipation even in the low load condition, hence reducing the operating expenses effectively, while simultaneously ensuring uptime.

### Simple

Thanks to the hot-swap design of power modules and bypass module, the system can be expanded and maintained easily. Moreover, Huawei provides comprehensive and customized solutions that can abate customers' work greatly.

# Contents

UPS2000-A Series (1-3kVA).....	01
UPS2000-A Series (6-10kVA) .....	03
UPS2000-G Series (1-20kVA).....	05
UPS5000-E Series (25-75kVA Battery Integrated Solution) ...	07
UPS5000-E Series (25-125kVA) .....	09
UPS5000-E Series (40-800kVA) .....	11
UPS5000-E Series (50-800kVA) .....	13
UPS5000-S Series (50-800kVA).....	15
UPS5000-A Series (30-120kVA) .....	17
UPS5000-A Series (200-800kVA) .....	19
iBMS Wireless Battery Monitoring System.....	21
Intelligent Management System.....	23
Optional Components .....	25



UPS2000-A Series  
(1-10kVA)



UPS2000-G Series  
(1-20kVA)



UPS5000-E Series  
(25-800kVA)



UPS5000-S Series  
(50-800kVA)

# UPS2000-A Series

## (1-3kVA)

### Introduction

---

UPS2000-A series with a capacity ranging from 1kVA to 3kVA is an online double conversion power system that delivers continuous, high-quality AC Power. It's really a perfect power protection solution for small power scenarios.

### Scenarios

---

- Small and medium enterprises, large enterprise branch offices, bank branches and other small data centers
- Networks, communications systems, automatic control systems and other precision equipment
- Family, office

### Features

---

#### Reliable

- Wide input voltage range to minimize battery use
- Online double conversion power system provides continuous, high-quality AC Power

#### Efficient

- Efficiency up to 90%, reduce energy consumption, green and energy-saving
- Ultra small volume, compared to the traditional UPS system to save space

#### Simple

- LCD screen supports real-time monitoring and convenient operation
- Built-in battery, easy to use
- Enables quick and easy configuration of the UPS
- NetEco network manager, supporting centralized management to all the UPSs



UPS2000-A-1K/2K/3K

## Specifications

Rated capacity (kVA/kW)		1kVA/0.8kW	2kVA/1.6kW	3kVA/2.4kW	
Input: Output		1-in: 1-out			
Mains Input	Input Wiring	L+N+PE			
	Rated Voltage	220/230/240VAC			
	Input Voltage Range	110-300VAC			
	Input Frequency Range	40-70Hz			
	Input Power Factor	0.99			
Bypass Input	Input Rated Voltage	220/230/240VAC			
	Input Voltage Range	174-264VAC			
	Input Frequency Range	47-53Hz / 57-63Hz			
Battery	Battery Voltage	Standard	24VDC	48VDC	72VDC
		Long Backup	36VDC	72VDC	96VDC
	Backup Time	Standard	>5 minutes @ 80% load		
		Long Backup	Depending on the capacity of external batteries		
Output	Output Wiring	L+N+PE			
	Output Connections	4 X IEC C13	6 X IEC C13	6 X IEC C13 + 1 X IEC C19	
	Rated Voltage	220/230/240VAC $\pm$ 1%			
	Output Frequency	Tracking the bypass input (Normal mode); 50/60Hz $\pm$ 0.05%			
	Output Power Factor	0.8			
	Waveform	Sinewave, THDv< 3%			
	System Efficiency	88%	89%	90%	
	Overload Capacity	$\leq$ 110% overload for 10 minutes; $\leq$ 130% overload for 1 minute; $\leq$ 150% overload for 3 seconds			
Environment	Operating Temperature	0 to 40°C			
	Storage Temperature	-40 to +70°C (battery: -20 to +40°C)			
	Relative Humidity	0%–95% RH (no condensation)			
	Operating Altitude	0-1000m. Above 1000m, derating 1% for each additional 100m			
	Audible Noise	<50dB			
Others	D x W x H (mm)	Standard	282 x 145 x 220	397 x 145 x 220	421 x 190 x 318
		Long Backup	282 x 145 x 220	397 x 145 x 220	397 x 145 x 220
	Weight (kg)	Standard	9.2	16.8	27
		Long Backup	4.1	6.7	7.4
	Certifications	EN/IEC 62040-1; EN/IEC 62040-2; EN/IEC 62040-3; CE; CB; RoHS, REACH, WEEE, RCM, etc			
	Communications	USB&RS232(optional RS485/Dry contact/SNMP)			

# UPS2000-A Series

## (6-10kVA)

### Introduction

---

UPS2000-A series (6-10kVA) is a tower-mounted, online double conversion power system that delivers continuous, high-quality AC Power. up to 96% efficiency at online mode for 6/10kVA models helps save 50% energy cost. It's really a perfect power protection solution for small power scenarios.

### Scenarios

---

- Small and medium enterprises, large enterprise branch offices, bank branches and other small data centers
- Networks, communications systems, automatic control systems and other precision equipment
- Family, office

### Features

---

#### Reliable

- Wide input voltage range to minimize battery use
- Key component failure pre-alarm including fans, batteries to remind customers to maintain before failure occurs
- Coating design & key device pin special protection enhance reliability

#### Efficient

- High efficiency of up to 96% at online mode for 6/10kVA reduces power loss of UPS and air conditioner and saves customers more than 50% over less efficient models
- The output power factor is 0.9, high load capacity

#### Simple

- LCD screen supports real-time monitoring and convenient operation
- Built-in battery design provides you integrated solution and makes it especially applicable for space-scarce use
- 6kVA/10kVA Professional Edition supports 4 machines in parallel operation, built in maintenance bypass, easy to use
- The NetEco 1000U management system monitors UPSs in real time and allows users easy management, and operation
- Multiple remote monitoring: supports SMS, E-mail, etc
- NetEco network manager, supporting centralized management to all the UPSs



UPS2000-A-6K/10K



## Specifications

Rated capacity (kVA/kW)		6kVA/5.4kW (Standard Version)		10kVA/9kW (Standard Version)		6kVA/5.4kW (Professional version)		10kVA/9kW (Professional Version)		
Model		UPS2000-A-6KTTL-S UPS2000-A-6KTTS-S		UPS2000-A-10KTTL-S UPS2000-A-10KTTS-S		UPS2000-A-6KTTL-P UPS2000-A-6KTTS-P		UPS2000-A-10KTTL-P UPS2000-A-10KTTS-P		
Input: Output		1 phase input, 1 phase output				1 phase input, 1 phase output; dual-live-wire input, dual-live-wire output				
Mains	Input Wiring	L+N+PE				L+N+PE/2Ph+PE				
	Rated Input Voltage	220/230/240V AC				208/220/230/240V AC				
	Input Voltage Range	80-280V AC								
	Input Frequency Range	50/60Hz ± 5Hz								
	Input power factor	≥ 0.99								
	Total Harmonic Distortion	Total Harmonic Distortion of current <3% at rated load								
Bypass Input	Input rated voltage	220/230/240V AC				208/220/230/240V AC				
	Input frequency range	50/60Hz ± 5Hz								
Battery	Battery voltage	Standard	192V DC	192V DC	240V DC	240V DC	240V DC	240V DC		
		Long backup	192-240V DC	192-240V DC	192-240V DC	192-240V DC	192-240V DC	192-240V DC		
	Backup time	Standard	> 5 minutes at 80% rated load	> 4 minutes at 80% rated load	> 6 minutes at 80% rated load	> 5 minutes at 80% rated load	> 5 minutes at 80% rated load	> 5 minutes at 80% rated load		
		Long backup	Depending on the capacity of external batteries							
Output	Output wiring	L+N+PE				L+N+PE/2Ph+PE				
	Rated voltage	220/230/240V AC ±1%				208/220/230/240V AC ±1%				
	Output frequency	Tracking the bypass input (Normal mode); 50/60Hz ± 0.05% (Battery Mode)								
	Output power factor	0.9								
	Waveform	Sine wave, THDv ≤ 2%								
System	Maintenance Bypass	No Built-in Maintenance Bypass				Built-in Maintenance Bypass				
	Expandability	----				Up to 4 units connected in parallel				
	Efficiency	96%								
	Overload capacity	≤125% overload for 5 minutes; ≤150% overload for 1 minute								
Environment	Operating Temperature	0°C to 40°C								
	Relative Humidity	0%–95% RH (no condensation)								
	Altitude	0-1000m. Above 1000m, derating 1% for each additional 100m								
	Audible Noise	<50dB								
Others	Height×Width×Depth (mm)		580 x 250 x 605							
	Weight	Standard	60kg	67kg	70kg	79kg	79kg	79kg		
		Long backup	20kg	21kg	21kg	22kg	22kg	22kg		
	Certifications		EN/IEC62040-1, EN/IEC62040-2, EN/IEC62040-3, CE, CB, RoHS, REACH, WEEE, RCM, etc.							
Communications		USB(optional RS485/Dry contact/SNMP)								

# UPS2000-G Series

## (1-20kVA)

### Introduction

---

UPS2000-G series with a capacity ranging from 1kVA to 20kVA is an online double conversion power system that delivers continuous, high-quality AC power. It is rack/tower convertible and 95% high efficiency helps it get ECA energy saving certification from United Kingdom government and the world's first batch of "Energy Star" certification. It's really a perfect power protection solution for small power scenarios.

### Scenarios

---

- Small and medium-sized enterprises, large enterprise branch offices, bank branches and other small data centers
- Networks, communications systems, automatic control systems and other precision equipment

### Features

---

#### Reliable

- 5kA lightning protection design, reducing lightning-related failure rate
- Key component failure pre-alarm including fans, batteries, bus capacitors to remind customers to maintain before failure occurs
- Ultra-wide voltage input range to extend battery service life by effectively reducing times of switchover to battery mode

#### Efficient

- High efficiency at online mode to reduce power loss of UPS and air conditioner: up to 95% for 15/20kVA, 94.5% for 10kVA, 94% for 6kVA

#### Simple

- Rack/tower convertible, suitable for different installation scenarios
- High expandability design: up to four units can be connected in parallel to achieve higher capacity or reliability
- NetEco network manager, supporting centralized management to all the UPSs



UPS2000-G-1K/2K/3K



UPS2000-G-6K/10K



UPS2000-G-15K/20K

## Specifications

Rated Capacity(kVA/kW)		1/0.8	2/1.6	3/2.4	6/5.4	10/9	15/13.5	20/18		
Input: Output		1-in: 1-out				1-in: 1-out or 3-in: 1-out	1-in: 1-out, 3-in: 1-out or 3-in: 3-out			
Mains Input	Input Wiring	L+N+PE				L+N+PE /3Ph+N+PE				
	Rated Voltage	200/208/220/230/240V AC			L-N: 220/230/240V AC					
	Input Voltage Range	110-300V AC			L-N: 80-280V AC					
	Input Frequency Range	40-70Hz								
	Input Power Factor	0.99								
Bypass Input	Rated Voltage	200/208/220/230/240V AC			L-N: 220/230/240V AC					
	Frequency	50/60 ± 3Hz			50/60 ± 6Hz					
Battery	Rated Voltage	Standard	24V DC	48V DC	72V DC	240V DC		---		
		Long Backup	36V DC	72V DC	96V DC	192-240V DC		384-480V DC, 32-40 section adjustable, default 40		
Output Wiring		L+N+PE				L+N+PE /3Ph+N+PE				
Output Sockets		4 × C13 (10A)	6 × C13 (10A)	6 × C13 (10A)+1 × C19 (16A)	2 × C13 (10A)	—				
Rated Voltage		200/208/220/230/240V AC ±1%			220/230/240V AC ±1%		L-N: 220/230/240V AC ±1%			
Rated Frequency		1-3K: Tracking the bypass input (Normal mode); 50/60 Hz±0.05% (Battery mode); 6-20K: Tracking the bypass input (Normal mode); 50/60 Hz±0.05% (Battery mode)								
Waveform		Sine wave, THDv<3%				Sine wave, THDv<2%				
Efficiency		88%	89%	90%	94%	94.5%	95%			
Enviro- nment	Operating Temperature		0-40°C							
	Storage Temperature		-40 to 70°C							
	Relative Humidity		0%-95% (No condensing)							
	Operating Altitude		0-1000m. Above 1000m, derating 1% for each additional 100m							
	Audible Noise		<50dB			<55dB		<58dB		
Others	H × W × D (mm)	Standard	88 × 438 × 310		88 × 438 × 410	88 × 438 × 630		86 × 430 × 585		130 × 430 × 685
		Long Backup	88 × 438 × 310		88 × 438 × 410		88 × 438 × 630		86 × 430 × 585	
	Weight	Standard	10.7kg	18.5kg	27.9kg	14kg		16kg	32kg	
		Long Backup	5.9kg	8.6kg	9.2kg	14kg		16kg	32kg	
	Certifications		EN/IEC 62040-1; EN/IEC 62040-2; EN/IEC 62040-3; CE; CB; RoHS, REACH, WEEE, RCM, etc							
Communications		USB&RS232(optional RS485/Dry contact/ SNMP)				USB(optional RS485/Dry contact/SNMP)				

\* 6kVA & 10kVA UPS have 2 versions: standard version and long backup time version

# UPS5000-E Series

## (25-75kVA Battery Integrated Solution)

### Introduction

---

UPS5000-E Battery Integrated Solution features the double-conversion online and modular design with pre-integrated battery module, fast on-site deployment & installation, intelligent management, unattended operation and simple O&M, thus providing customers with reliable, efficient and simple modular UPSs.

### Scenarios

---

- Small-to-medium sized data centers
- Telecom and Internet switch computer rooms of small-to-medium sized enterprises
- Area network and communication equipment rooms
- Computer rooms of branch offices of industries like finance, etc

### Features

---

#### Reliable

- Wide input voltage range from 138Vac to 485Vac to suit for worst grid and minimize battery use
- Dual-controller design to eliminate the single point of failure
- Redundant auxiliary power supply and fans
- Intelligent Battery Management: monitoring battery's temperature, early warning for failure, battery powered high reliability.

#### Efficient

- High efficiency of power module up to 96.5%
- Intelligent hibernation technology to keep UPS operating at high efficiency
- All in one design, saving the area of 50%

#### Simple

- Modularized power, bypass, control and battery modules, fast installation and maintenance
- 7-inch colored LCD showing real-time operation status in various languages
- Various communication interfaces including dry contacts, RS485, Modbus etc.
- NetEco network manager, supporting centralized management to all the UPSs



Power Module: 25kVA/2U



Integrated Cabinet  
25kVA-75kVA



Battery Cabinet

## Specifications

Model		UPS5000-E-(25-75kVA)-B		
Capacity (kVA/kW)		25kVA/kW	50kVA/kW	75kVA/kW
Input	Mains	Rated Voltage	380/400/415Vac	
		Voltage Range	138 to 485Vac	
		Input Wiring	3Ph+N+PE	
		Frequency Range	40 to 70 Hz	
		Total Harmonic Distortion	<3% (100% linear load)	
		Input Power Factor	0.99	
	Bypass	Rated Voltage	380/400/415Vac	
		Frequency Range	50/60Hz (adjustable, 0.5 to 6Hz, $\pm 2$ Hz by default)	
		Input Wiring	3Ph+N+PE	
Output	Rated Voltage	380/400/415Vac		
	Output Frequency	Tracking the bypass input (Normal mode); 50/60Hz $\pm 0.05\%$ (Battery mode)		
	Output Power Factor	1		
	Waveform	Sine wave; THDv<1% (linear load)		
	Output Wiring	3Ph+N+PE		
	System Efficiency	96%		
	Overload Capacity	$\leq 110\%$ overload for 60min; $\leq 125\%$ overload for 10min; $\leq 150\%$ overload for 1min		
Environment	Operation Temperature	0 to 40 °C		
	Storage Temperature	-40 to 70 °C		
	Relative Humidity	0% to 95% (No condensing)		
	Maximum Operation Altitude	0 to 1000m. Above 1000m, derating 1% for each additional 100m		
	Noise	65dB		
Others	Integrated Cabinet Power Backup	Standard configuration 1 to 4 groups of battery (4 to 16 battery modules)		
	Battery Cabinet (optional) Power Backup	Optional battery cabinet, 1 to 8 groups of battery (4 to 32 battery modules) per cabinet, max. 4 cabinets in parallels		
	Battery Module	Hot swappable design. Support battery or empty battery for battery module, battery typical configuration: 10 $\times$ 12V 9aH		
	Height $\times$ Width $\times$ Depth (mm)	2000 $\times$ 600 $\times$ 1100		
	Weight	747.4kg	766.5kg	785.6kg
	Certifications	EN/IEC 62040-1, EN/IEC 62040-2, EN/IEC 62040-3, CE, CB, etc.		
	Communications	SNMP, RS485, Dry contacts etc.		

# UPS5000-E Series

## (25-125kVA)

### Introduction

---

Based on the online double conversion technology, UPS5000-E series (25-125kVA) can provide reliable, pure and uninterrupted power for critical ICT equipment. The modularized architecture helps improve the availability and reduce the engineering cost significantly.

### Scenarios

---

- Small & medium data center, large enterprise regional datacenter
- Central offices, dispatch center, control center, etc.

### Features

---

#### Reliable

- 138-485Vac ultra-wide input voltage range, suitable for the worst power grid
- Redundant design for modules, elimination of the single point of failure
- iPower pre-warnings for key components in case of power supply interruption

#### Efficient

- High efficiency up to 96% at most frequently-used load rate, reducing power consumption of UPS and cooling efficiency
- Intelligent hibernation technology ensures efficient UPS operation

#### Simple

- Hot swappable power module, bypass module and control module, simple maintenance and expansion in 5 minutes
- iPower real time monitoring system for UPS, PDU and batteries, elimination of manual routing inspection



25kVA Power Module @ 2U



UPS5000-E-125K-FM

## Specifications

Model		UPS5000-E-125K-FM				
Rated Capacity (kVA/kW)		25kVA/kW	50kVA/kW	75kVA/kW	100kVA/kW	125kVA/kW
Number of Power Modules		1	2	3	4	5
Mains Input	Input Wiring	3Ph+N+PE				
	Rated Voltage	380/400/415Vac				
	Voltage Range	138-485Vac				
	Input Frequency	40-70Hz				
	Total Harmonic Distortion	THDi<3% for linear load				
	Input Power Factor	0.99				
Bypass Input	Input Wiring	3Ph+N+PE				
	Rated Voltage	380/400/415Vac				
	Input Frequency	50/60 ± 6Hz				
Battery	Rated Voltage	360-480Vdc (The number of batteries can be selected from 30 to 40; 32 batteries in default)				
Output	Output Wiring	3Ph+N+PE				
	Voltage	380/400/415Vac±1%				
	Frequency	Tracking the bypass input (Normal mode); 50/60Hz±0.05% (Battery mode)				
	Waveform	Sine wave (THDv<1% for linear load)				
	Output Power Factor	1				
	Overload Capacity	Inverter: 110% overload for 60 minutes; 125% overload for 10 minutes; 150% overload for 1 minute				
	Efficiency	96%				
Environment	Operating Temperature	0-40°C				
	Storage Temperature	-40 to 70°C				
	Relative Humidity	0%-95% (No condensing)				
	Operating Altitude	0-1000m. Above 1000m, derating 1% for each additional 100m				
Others	Height×Width×Depth (mm)	2000 × 600 × 850				
	Weight	201.8kg	220.9kg	240.8kg	259.9kg	279kg
	Certifications	EN/IEC 62040-1; EN/IEC 62040-2; EN/IEC 62040-3; CE; CB; RoHS, REACH, WEEE, etc.				
	Communications	Dry contacts, RS485, SNMP				

# UPS5000-E Series

## (40-800kVA)

### Introduction

---

UPS5000-E Series (40-800kVA) is an advanced modular UPS based on Huawei's extensive experience in digital technology and power electronics. Benefiting from high performance DSP and high speed communication technology, the UPS5000-E system achieves leading expandability and availability. Its high efficiency, high availability match the requirements of cloud data center perfectly.

### Scenarios

---

- Data centers in headquarter or disaster recovery data centers
- Internet data centers
- Large cloud computing data centers

### Features

---

#### Reliable

- 138-485Vac ultra-wide input voltage range, suitable for the worst power grid
- Redundant design for modules, elimination of the single point of failure
- iPower pre-warnings for key components in case of power supply interruption

#### Efficient

- High module efficiency up to 96% and system efficiency up to 95%-96% at most frequently-used load rate
- Intelligent hibernation technology ensures efficient UPS operation
- The footprint is 0.51m<sup>2</sup> for 320kVA UPS, 50% footprint saving, more IT rack space

#### Simple

- Hot swappable power module, bypass module and control module, simple maintenance and expansion in 5 minutes
- iPower real time monitoring system for UPS, PDU and batteries, elimination of manual routing inspection



UPS5000-E-480K-F480



UPS5000-E-800K-F800



## Specifications

Model		UPS5000-E-120K	UPS5000-E-200K	UPS5000-E-320K	UPS5000-E-480K	UPS5000-E-600K	UPS5000-E-800K
Rated Capacity (kVA/kW)		40-120	40-200	40-320	40-480	40-600	40-800
Number of Power Modules		1-3	1-5	1-8	1-12	1-15	1-20
Mains Input	Input Wiring	3Ph+N+PE					
	Rated Voltage	380/400/415Vac					
	Voltage Range	138-485Vac (305-485Vac for 100% load; 138-305Vac for 40%-100% load)					
	Frequency Range	40-70Hz					
	Total Harmonic Distortion	THDi<3% for 100% linear load					
	Input Power Factor	0.99					
Bypass Input	Rated Voltage	380/400/415Vac					
	Input Frequency	50/60±6Hz					
Battery	Rated Voltage	360-480Vdc (The number of batteries can be selected from 30 to 40; 32 batteries in default)					
Output	Output Wiring	3Ph+N+PE					
	Voltage	380/400/415Vac±1%					
	Frequency	Tracking the bypass input (Normal mode); 50/60Hz±0.05% (Battery mode)					
	Waveform	Sine wave (THDv<1% for linear load)					
	Overload Capacity	Inverter: 110% overload for 60 minutes; 125% overload for 10 minutes; 150% overload for 1 minute					
System	Output Power Factor	1					
	Efficiency	Up to 96%					
	Expandability	8					
Environment	Operating Temperature	0-40°C					
	Storage Temperature	-40 to 70°C					
	Relative Humidity	0%-95% (No condensing)					
	Operating Altitude	0-1000m. Above 1000m, derating 1% for each additional 100m					
	Audible Noise	66-75dB					
Others	Height×Width×Depth(mm)	2000 × 600 × 850			2000 × 1200 × 850	2000 × 2000 × 850	2000×2400×850
	Weight	227-291kg	227-355kg	253-477kg	654-1006kg	902-1350kg	1062-1670kg
	Certifications	EN/IEC 62040-1; EN/IEC 62040-2; EN/IEC 62040-3; CE; CB; RoHS, REACH, WEEE, etc.					
	Communications	Dry contacts, RS485, SNMP					

# UPS5000-E Series

## (50-800kVA)

### Introduction

---

UPS5000-E Series (50-800kVA) is an advanced modular UPS based on Huawei's extensive experience in digital technology and power electronics. Benefiting from high performance DSP and high speed communication technology, the UPS5000-E system achieves leading expandability and availability. Its high efficiency, high availability match the requirements of cloud data center perfectly.

### Scenarios

---

- Data centers in headquarter or disaster recovery data centers
- Internet data centers
- Large cloud computing data centers

### Features

---

#### Reliable

- 138-485Vac ultra-wide input voltage range, suitable for the worst power grid
- Redundant design for modules, elimination of the single point of failure
- iPower pre-warnings for key components in case of power supply interruption

#### Efficient

- High efficiency up to 95%-96% at most frequently-used load rate
- Intelligent hibernation technology ensures efficient UPS operation
- Single cabinet power capacity up to 600kVA, 50% footprint saving, more IT rack space

#### Simple

- Hot swappable power module, bypass module and control module, simple maintenance and expansion in 5 minutes
- iPower real time monitoring system for UPS, PDU and batteries, elimination of manual routing inspection



UPS5000-E-200/300K



UPS5000-E-400/500K

## Specifications

Model		UPS5000-E-200K	UPS5000-E-300K	UPS5000-E-400K	UPS5000-E-500K	UPS5000-E-600K	UPS5000-E-800K
Rated Capacity (kVA/kW)		50-200	50-300	50-400	50-500	50-600	50-800
Number of Power Modules		1-4	1-6	1-8	1-10	1-12	1-16
Mains Input	Input Wiring	3Ph+N+PE					
	Rated Voltage	380/400/415Vac					
	Voltage Range	138-485Vac (305-485Vac for 100% load; 138-305Vac for 40%-100% load)					
	Frequency Range	40-70Hz					
	Total Harmonic Distortion	THDi<3% for 100% linear load					
	Input Power Factor	0.99					
Bypass Input	Rated Voltage	380/400/415Vac					
	Input Frequency	50/60±6Hz					
Battery	Rated Voltage	360-552Vdc (The number of batteries can be selected from 30 to 46; 40 batteries in default)					
Output	Output Wiring	3Ph+N+PE					
	Voltage	380/400/415Vac±1%					
	Frequency	Tracking the bypass input (Normal mode); 50/60Hz±0.05% (Battery mode)					
	Waveform	Sine wave (THDv<1% for linear load)					
	Overload Capacity	Inverter: 110% overload for 60 minutes; 125% overload for 10 minutes; 150% overload for 1 minute					
System	Output Power Factor	1					
	Efficiency	Up to 96%					
	Expandability	8					
Environment	Operating Temperature	0-40°C					
	Storage Temperature	-40 to 70°C					
	Relative Humidity	0%-95% (No condensing)					
	Operating Altitude	0-1000m. Above 1000m, derating 1% for each additional 100m					
	Audible Noise	66-75dB					
Others	Height×Width×Depth(mm)	2000 × 600 × 850		2000 × 1200 × 850		2000 × 1400 × 850	2000 × 2400 × 850
	Weight	224-350kg	250-410kg	461-685kg	647-935kg	708-1060kg	1060-1540kg
	Certifications	EN/IEC 62040-1; EN/IEC 62040-2; EN/IEC 62040-3; CE; CB; RoHS, REACH, WEEE, etc.					
	Communications	Dry contacts, RS485, SNMP					

# UPS5000-S Series

## (50-800kVA)

### Introduction

UPS5000-S Series (50-800kVA) is an advanced modular UPS based on Huawei's extensive experience in digital technology and power electronics. Benefiting from high performance DSP and high speed communication technology, the UPS5000-S system achieves leading expandability and availability. Its high efficiency, high availability match the requirements of cloud data center perfectly.

### Scenarios

- Data centers in headquarter or disaster recovery data centers
- Internet data centers
- Large cloud computing data centers

### Features

#### Reliable

- 138-485Vac ultra-wide input voltage range, suitable for the worst power grid
- Redundant design for modules, elimination of the single point of failure
- iPower pre-warnings for key components in case of power supply interruption

#### Efficient

- High module efficiency up to 97.5% and system efficiency up to 96.5%-97% at most frequently-used load rate
- Intelligent hibernation technology ensures efficient UPS operation
- Single cabinet power capacity up to 600kVA, 50% footprint saving, more IT rack space

#### Simple

- Hot swappable power module, bypass module and control module, simple maintenance and expansion in 5 minutes
- iPower real time monitoring system for UPS, PDU and batteries, elimination of manual routing inspection



Power Module: 50kVA/3U & 97.5% efficiency



UPS5000-S-200kVA



UPS5000-S-200/300kVA



UPS5000-S-400/500kVA



UPS5000-S-600kVA



UPS5000-S-800kVA

## Specifications

Model		UPS5000-S-200K	UPS5000-S-300K	UPS5000-S-400K	UPS5000-S-500K	UPS5000-S-600K	UPS5000-S-800K
Rated Capacity (kVA/kW)		50-200	50-300	50-400	50-500	50-600	50-800
Number of Power Modules		1-4	1-6	1-8	1-10	1-12	1-16
Mains Input	Input Wiring	3Ph+PE (Neutral wire: optional)					
	Rated Voltage	380/400/415Vac					
	Voltage Range	138-485Vac (305-485Vac for 100% load; 138-305Vac for 40%-100% load)					
	Frequency Range	40-70Hz					
	Total Harmonic Distortion	THDi<3% for 100% linear load					
	Input Power Factor	0.99					
Bypass Input	Input Wiring	3Ph+N+PE					
	Rated Voltage	380/400/415Vac					
	Input Frequency	50/60±6Hz					
Battery	Rated Voltage	384-600Vdc (The number of batteries can be selected from 32 to 50; 40 batteries in default)					
Output	Output Wiring	3Ph+N+PE					
	Voltage	380/400/415Vac±1%					
	Frequency	Tracking the bypass input (Normal mode); 50/60Hz±0.05% (Battery mode)					
	Waveform	Sine wave (THDv<1% for linear load)					
	Overload Capacity	Inverter: 110% overload for 60 minutes; 125% overload for 10 minutes; 150% overload for 1 minute					
System	Output Power Factor	1					
	Efficiency	Up to 97.1%					
	Expandability	8					
Environment	Operating Temperature	0-40°C					
	Storage Temperature	-40 to 70°C					
	Relative Humidity	0%-95% (No condensing)					
	Operating Altitude	0-1000m. Above 1000m, derating rate based on EN/IEC 62040-3					
	Audible Noise	66-75dB					
Others	Height×Width×Depth(mm)	2000 × 600 × 850		2000 × 1200 × 850		2000 × 1400 × 850	2000 × 2400 × 850
	Weight	225-354kg	251-416kg	462-693kg	648-945kg	709-1072kg	1061-1556kg
	Certifications	EN/IEC 62040-1; EN/IEC 62040-2; EN/IEC 62040-3; CE; CB; RoHS, REACH, WEEE, etc.					
	Communications	Dry contacts, RS485, SNMP					

# UPS5000-A Series

## (30-120kVA)

### Introduction

---

The UPS5000-A (30-120kVA) is an online, double-conversion, and tower/rack convertible UPS that Huawei has launched. It uses the digital signal processing (DSP) technology to output pure and stable sine wave with a voltage of 380/400/415 Vac. With comprehensive reliability assurance measures and other leading technologies, the UPS5000-A (30-120kVA) can provide reliable, economical, intelligent, and convenient solutions to medium power scenarios.

### Scenarios

---

- Small and medium-sized data centers
- Telecom and Internet switch rooms
- Equipment rooms of branch offices in sectors such as finance
- Infrastructures, such as control equipment rooms, wireless systems, etc.

### Features

---

#### Reliable

- Wide input voltage range to minimize battery use: 485-305 Vac for 100% load; 305-138 Vac for 100%-40% load (derating linearly)
- High output power factor of up to 1, 30% more load driven than traditional UPS

#### Efficient

- High efficiency at online mode of up to 95.7%, reducing power consumption of UPS and cooling equipment effectively

#### Simple

- Rack/tower convertible, suitable for different installation scenarios
- Flexible battery configuration: 30-40 batteries per string allow customers to get the faulty battery out instead of replacing it



UPS5000-A-30/40K



UPS5000-A-60/80/120K

## Specifications

Rated Capacity (kVA/kW)		30kVA/30kW	40kVA/40kW	60kVA/60kW	80kVA/80kW	120kVA/120kW
Mains Input	Input Wiring	3Ph+N+PE				
	Rated Voltage	380/400/415Vac				
	Voltage Range	138-485Vac				
	Frequency Range	40-70Hz				
	Total Harmonic Distortion	THDi<3% for 100% linear load				
	Input Power Factor	0.99				
Bypass Input	Input Wiring	3Ph+N+PE				
	Rated Voltage	380/400/415Vac				
	Input Frequency	50/60±6Hz				
Battery	Rated Voltage	360-480Vdc (The number of batteries can be selected from 30 to 40; 32 batteries in default)				
Output	Output Wiring	3Ph+N+PE				
	Rated Voltage	380/400/415Vac±1%				
	Frequency	Tracking the bypass input (Normal mode); 50/60Hz±0.05% (Battery mode)				
	Waveform	Sine wave (THDv<1% for 100% linear load)				
	Overload Capacity	110% overload for 60 minutes; 125% overload for 10 minutes; 150% overload for 1 minute				
System	Output Power Factor	1				
	Efficiency	Up to 95.7%				
	Expandability	Up to 8 units connected in parallel				
Environment	Operating Temperature	0-40°C				
	Storage Temperature	-40 to 70°C				
	Relative Humidity	0%-95% (No condensing)				
	Operating Altitude	0-1000m. Above 1000m, derating 1% for each additional 100m				
	Audible Noise	58-64dB				
Others	Height×Width×Depth (mm)	500 × 264 × 800		1020 × 440 × 850		
	Weight	70kg		200kg		240kg
	Certifications	EN/IEC 62040-1; EN/IEC 62040-2; EN/IEC 62040-3; CE; CB; RoHS, REACH, WEEE, etc.				
	Communications	Dry contacts, RS485, SNMP				

# UPS5000-A Series

## (200-800kVA)

### Introduction

---

Huawei UPS5000-A (200-800kVA) is an online double conversion UPS which can output pure sine wave with rated voltage of 380/400/415 Vac. UPS5000-A has a high efficiency of up to 96% and high power density of up to 300kVA per cabinet; all-digital control allows precise output at any input and load condition. It's suitable to ensure continuous power supply to critical loads in large datacenters.

### Scenarios

---

- Large data centers, server rooms, security systems of finance, telecom and other large enterprises
- Data center of government or public institutions
- Precision instruments

### Features

---

#### Reliable

- Wide input voltage range to minimize battery use: 485-305 V for 100% load; 305-138 Vac for 100%-40% load (derating linearly)
- Better load adaptability: high output power factor up to 1 and no derating for capacitive or inductive devices with a PF>0.5

#### Efficient

- High efficiency of up to 96%, reducing power consumption effectively
- High power density of up to 300kVA per rack, 50% footprint saving compared with traditional UPS

#### Simple

- Flexible battery configuration: 30-40 batteries per string allow customers to get the faulty battery out instead of replacing it



UPS5000-A-200/300K



UPS5000-A-400/500K



## Specifications

Rated Capacity		200kVA/200kW	300kVA/300kW	400kVA/380kW	500kVA/475kW	600kVA/570kW	800kVA/760kW
Mains Input	Input Wiring	3Ph+N+PE					
	Rated Voltage	380/400/415Vac					
	Voltage Range	138-485Vac					
	Frequency Range	40-70Hz					
	Total Harmonic Distortion	THDi<3% for 100% linear load					
	Input Power Factor	0.99					
Bypass Input	Input Wiring	3Ph+N+PE					
	Rated Voltage	380/400/415Vac					
	Input Frequency	50/60±6Hz					
Battery	Rated Voltage	360-480Vdc (The number of batteries can be selected from 30 to 40; 32 batteries in default)					
Output	Output Wiring	3Ph+N+PE					
	Rated Voltage	380/400/415 Vac±1%					
	Frequency	Tracking the bypass input (Normal mode); 50/60 Hz±0.05% (Battery mode)					
	Waveform	Sine wave (THDv<1% for 100% linear load)					
	Overload Capacity	110% overload for 60 minutes; 125% overload for 10 minutes; 150% overload for 1 minute					
System	Output Power Factor	1			0.95		
	Efficiency	96%					
	Expandability	Up to 8 units connected in parallel					
Environment	Operating Temperature	0-40°C					
	Storage Temperature	-40 to 70°C					
	Relative Humidity	0%-95% (No condensing)					
	Operating Altitude	0-1000m. Above 1000m, derating 1% for each additional 100m					
	Audible Noise	65-70dB					
Others	Height×Width×Depth (mm)	2000 × 600 × 850		2000 × 1200 × 850		2000 × 2000 × 850	2000 × 2400 × 850
	Weight	360kg	480kg	900kg	1000kg	1274kg	1695kg
	Certifications	EN/IEC 62040-1; EN/IEC 62040-2; EN/IEC 62040-3; CE; CB; RoHS, REACH, WEEE, etc.					
	Communications	Dry contacts, RS485, SNMP					

# iBattery Intelligent Management Solution

## Product Introduction

iBattery is an intelligent battery management system based on wireless transmission. It can perform real-time detection of core parameters including voltage, current, temperature and internal resistance. Besides, through the linkage with Huawei UPS system, it can, by effectively identifying the SOH, provide automatic shutdown of battery group in an emergency so as to keep stable and reliable operation of the backup power system.

## Application Scenario

Operation with Huawei UPS, applicable to:

- 12V valve regulated lead acid battery
- 2V valve regulated lead acid battery

## Typical Networking Diagram

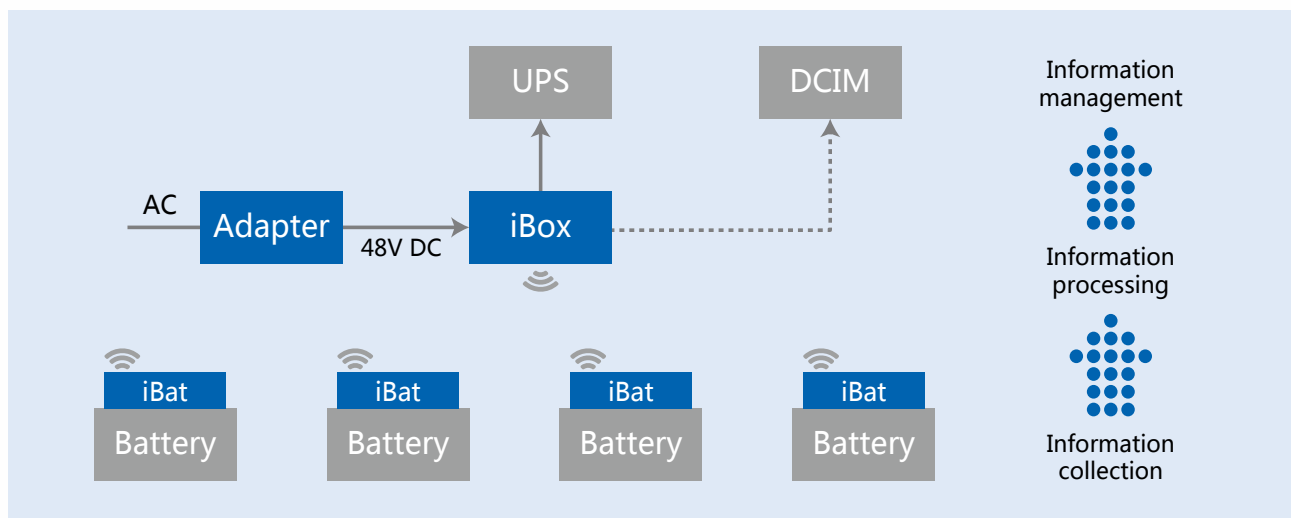

## Features & Values



Real-time detection, manual routing detection eliminated



Real-time calculation of SOH, automatic identification of weak cells



Linkage with UPS, automatic shutdown in case of emergent fault



Wireless connection, easy deployment

## iBox Technical Specifications



iBox

- Support 4 pieces in parallel
- Single iBox supports 300 iBats access
- Support automatic identification of weak cells
- Linkage with UPS, automatic shutdown in case of emergent fault (fire)

Type	iBox
iBat Access No.	300
Current Detection Precision	1%
Current Detection Input No.	8
SOC, SOH Detection Precision	±10%
DI/DO Interface	1 DI, 1 DO
Power Supply	12V or 48V
Southbound Communication Protocol	Zigbee
Northbound Communication Protocol	SNMP, modbus TCP, modbus RTU
Dimensions (H*W*D)	180mm×116mm×43.6mm
Weight	<0.45kg
Operating environment	-20 to 65°C

## iBat Technical Specifications



iBat

- "0" consumption, power supplied by battery
- Accurate detection for cell voltage, temperature, internal resistance
- Wireless connection, high reliability, easy expansion

Type	2V iBat	12V iBat
Single voltage measurement range	1.5V to 2.5V	9V to 15V
Single internal resistance measurement range	0.1 to 20mΩ	1.5mΩ to 100mΩ
Pole temp. measurement range	-20 to 125°C	
Voltage detection precision	±0.1%	
Pole temp. detection precision	±0.5°C	
Internal resistance detection precision	±2%	
Communications Mode	Zigbee	
Normal operation power consumption	<4w	
Current at low power consumption mode	<350uA	150uA
Poor connection of battery power cable	Yes	
Dimensions (H*W*D)	80mm×57mm×22.2mm	
Weight	<0.1kg	
Operating environment	-20 to 65°C	

# Intelligent Management System

## NetEco 1000U for UPS System Management

iManager NetEco 1000U can run on the Windows operating system and can be accessed through a web browser. The iManager NetEco 1000U enables you to monitor the key performance indicators (KPIs) and alarms of the UPSs in real time. In addition, it enables you to remotely control and manage the UPSs. This increases the centralized management and remote operation and maintenance capabilities for the UPSs. NetEco 1000U supports connection through USB Data lines, RS232 cable, or network cable.

## NetEco 6000 for Data Center Management

### Introduction

NetEco is a new generation data center management system launched by HUAWEI. It manages the real-time data and status of data center infrastructures, including power, environment, video, and door status and generates alarms if any fault occurs.

NetEco displays data center layouts and data reports for customers to easily query equipment status, and provides a standard platform to apply to all data center solutions due to its flexible configuration, smooth capacity expansion, and hierarchical management.

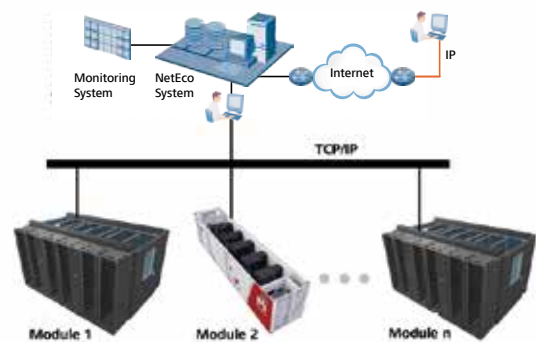

### Value & Features

#### High availability, warning and troubleshooting

- Foresight warning of faults and risks improves IDC availability
- Quickly faults location, virtual inspection

#### Smart interaction, energy saving

- Dynamic PUE management
- Optimizing important power and cooling services

#### Rapid deployment, one-button launching

- Pre-configured software and parameters, one-button launching
- Parameters of AC and UPS loading, testing time saving

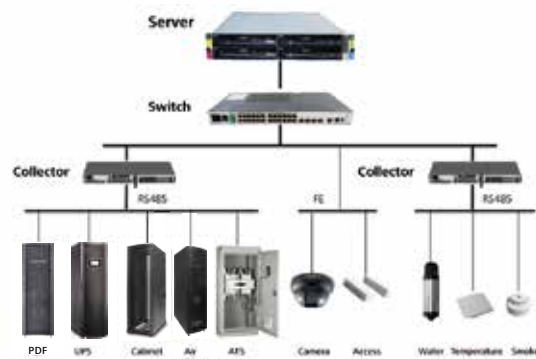

## Technical Specification

### Monitoring Systems

Bottom-layer equipment can be easily connected to NetEco over Modbus, Simple Network Management Protocol (SNMP), and intelligent equipment communication protocol. Customers can customize NetEco for the support of non-standard protocols. Bottom-layer devices monitored by the NetEco are classified into the power system, environment system, video system, and access system.

Power System	Environment System	Video System	Access System
Precision air conditioner, UPS, PDU, UPS input cabinet, UPS output cabinet, Precise PDF, AC PDF	Temperature and humidity sensor, smoke sensor, water sensor	Camera, NVR (Optional)	Door access controller

### Functions

NetEco provides comprehensive functions for managing data center infrastructures.

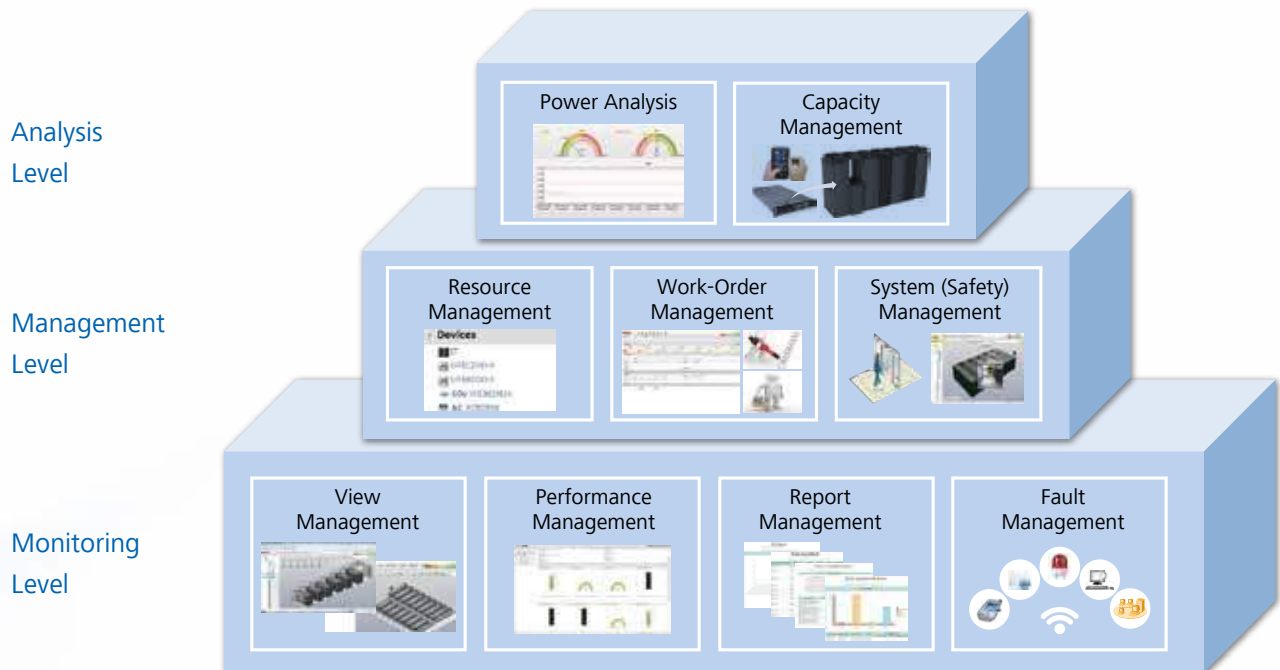

# Optional Components

## Communication cards for connectivity\*

Item	Introduction
RMS-SNMP01A (For UPS2000-G)	RMS-SNMP01A supports protocols including SNMP, HTTP, HTTPS, and SSH. Moreover, RMS-SNMP01A implements IP address control over HTTPS, SNMPv3, and SNMP access to prevent unauthorized access.
RMS-MODBUS01A (For UPS2000-G)	The Modbus card provides a RS485 networking solution for remote UPS management.
RMS-RELAY01A (For UPS2000-G)	The dry contact card provides six alarm dry contact outputs and two dry contract control inputs.
Dry contact extended card (For UPS5000 series)	The dry contact extended card provides five relay dry contact outputs and five signal input ports. The card implements additional alarm and control functions to meet customer requirements

\* UPS5000-E and UPS5000-A provide built-in SNMP, Modbus and dry contact interface



RMS-SNMP01A



RMS-MODBUS01A



RMS-RELAY01A



Dry contact extended card

## Environmental sensors

Item	Introduction
Battery temperature sensor	Battery temperature sensor can detect the battery temperature and provide reference for temperature compensation when floatcharging
Ambient temperature and humidity sensor	Ambient temperature and humidity sensor can feedback real-time temperature and humidity data to dynamic environment monitoring system and help customers achieve lean management

## Battery monitoring

Item	Introduction
Battery ground fault detector	The battery ground fault detector detects battery ground fault and sends alarm signals when the ground leakage current exceeds the threshold value



Battery ground fault detector

In addition, Huawei provides optional components including power distribution cabinets, battery switch boxes, and backfeed protection cards to meet various configuration requirements.

# Comprehensive Reliability Assurance

Comprehensive reliability activities in the whole process ensure the reliable operation of millions of Huawei power systems in various severe conditions.



EMC Lab



Long life test (40°C, 100% load, 180 days)



Airborne hygroscopic dust test



Aging test



Sampling test of thermal shock



Environment Lab



highly accelerated life test



External field test  
(High humidity and salt spray environment)



Enhanced conformal coating

## Global Service

Huawei has professional UPS service engineers deployed globally, providing global technical support with rapid response speed. Huawei provides customized services that include:

- 24x7 remote support
- Software support
- Active prevention
- Hardware support
- Onsite support
- Others

140+ country-level delivery management organizations

129+ country-level spare parts centers

300+ region-level warehousing centers

22,000+ servers

24x7 online service







Copyright © Huawei Technologies Co., Ltd. 2016. All rights reserved.

No part of this document may be reproduced or transmitted in any form or by any means without prior written consent of Huawei Technologies Co., Ltd.

#### Trademark Notice

 , HUAWEI, and  are trademarks or registered trademarks of Huawei Technologies Co., Ltd. Other trademarks, product, service and company names mentioned are the property of their respective owners.

#### General Disclaimer

The information in this document may contain predictive statements including, without limitation, statements regarding the future financial and operating results, future product portfolio, new technology, etc. There are a number of factors that could cause actual results and developments to differ materially from those expressed or implied in the predictive statements. Therefore, such information is provided for reference purpose only and constitutes neither an offer nor an acceptance. Huawei may change the information at any time without notice.

**HUAWEI TECHNOLOGIES CO., LTD.**

Huawei Industrial Base  
Bantian Longgang  
Shenzhen 518129, P.R. China  
Tel: +86-755-28780808  
Version No.: M3-040174-20160827-E-3.0

[www.huawei.com](http://www.huawei.com)