

User Manual

3KW/5KW PV Inverter

Table Of Contents

1. Introduction.....	1
1-1. Overview	1
1-1. Affecting Factors for Performance of the Inverter	1
2. Important Safety Warning	2
3. Unpacking & Overview.....	4
3-1. Packing List	4
3-2. Product Overview	4
4. Installation	5
4-1. Selecting Mounting Location	5
4-2. Mounting Unit with Wall Mounting Bracket.....	5
5. Grid (AC) Connection.....	7
5-1. Preparation	7
5-2. Connecting to the AC Utility.....	7
6. PV Module (DC) Connection	9
7. Communication	11
8. Commissioning.....	12
9. Operation	13
9-1. Interface	13
9-2. LCD Information Define	13
9-3. Operation Button.....	14
9-4 Query Menu Operation.....	14
9-5. Operation Mode & Display	16
10. Maintenance & Cleaning	17
11. Trouble Shooting	17
11-1. Warning Situation	17
11-2. Fault Reference Codes.....	17
12. Specifications	20

1. Introduction

1-1. Overview

This PV inverter is designed to convert solar electric (photovoltaic or PV) power into utility-grade electricity that can be sold to the local power company. This inverter is embedded with smart MPP tracker to allow the PV inverter to operate at optimum power output voltage.

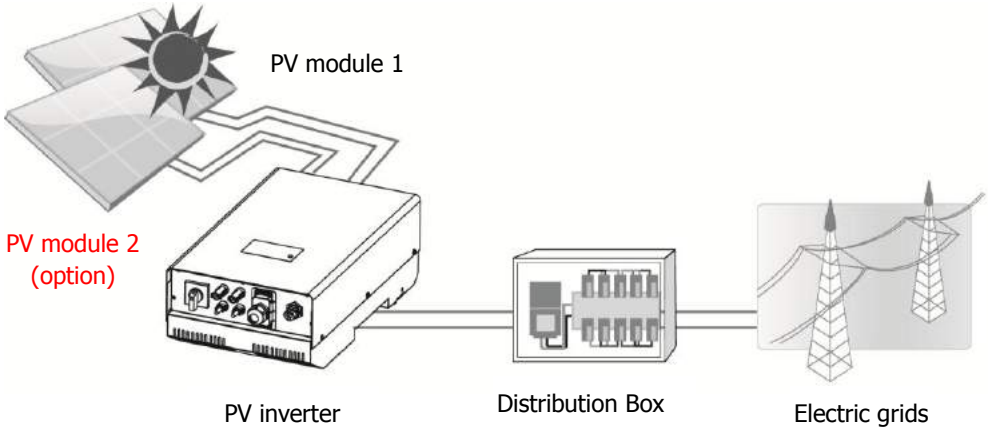

Figure 1 Basic PV System Overview

This inverter is only compatible with PV module types of single crystalline and poly crystalline. And, only Class A-rated PV modules are acceptable to use. Do not connect any sources of energy other than these two types of PV modules to the inverter. When designing the PV system, ensure that the values comply with the permitted operating range of all components at all times. See Figure 1 for a simple diagram of a typical PV system with the Inverter.

1-1. Affecting Factors for Performance of the Inverter

There are a lot of factors to influence the performance of this inverter.

Rating for PV Modules

PV modules are rated at ideal factory conditions, such as specified illumination (1000 W/m^2), spectrum of the light and temperature ($25 \text{ }^\circ\text{C} / 77 \text{ }^\circ\text{F}$). This is called the STC (Standard Test Condition) rating and is the figure that appears on the spec label of PV module. Generally speaking, only around 60% to 70% of its peak STC-rated output will be produced from your PV modules due to unpredicted environmental factors.

Temperature and Power Reduction

Environment temperature affects the power output of PV modules. Higher the temperature, lower the power output of PV module. Comparing with pole-mounted PV module array, roof-mounted PV module array generates less power due to less air circulation and excess heat from roof top.

Important: The inverter will reduce its output generation to protect its electronic circuits from overheating and any damage under high temperature environment. For maximum power output in high temperature, it's recommended to mount the inverter in a shaded location with good ventilation.

Angle of the Sun

The angle of the sun in relation to the PV array surface—the array orientation can dramatically affect the PV array output. The array energy output will vary depending on the time of day and time of year as the sun's angle in relation to the array changes. Sunlight output decreases as the sun approaches the horizons (such as in winter in Europe) due to the greater atmospheric air mass it must penetrate, reducing both the light intensity that strikes the array's surface and spectrum of the light. In general, you can expect only four to six hours of direct sunlight per day depending on what part of Europe the inverter is installed.

Partial Shade

Shading on a single PV module of the array will reduce the output power of the entire system. Such shading can be caused by something as simple as the shadow of a utility wire or tree branch on part of the array's surface. This condition, in effect, acts like a weak battery in a flashlight, reducing the total output, even though the other batteries are good. However, the output loss is not proportionate to shading even a tiny bit of shading will reduce the PV power to the inverter. The inverter is designed to maximize its power production in all of the above situations using its proprietary MPPT algorithm.

Other Factors

Other factors to reduce power generation of a solar system are:

- Dust or dirt on the modules
- Fog or smog
- Mismatched PV array modules, with slight inconsistencies in performance from one module to another.
- Inverter efficiency
- Wire losses
- Utility grid voltage

2. Important Safety Warning

Before using the inverter, please read all instructions and cautionary markings on the unit and this manual. Store the manual where it can be accessed easily.

This manual is for qualified personnel. The tasks described in this manual may be performed by qualified personnel only.

General Precaution-

Conventions used:

WARNING! Warnings identify conditions or practices that could result in personal injury;
CAUTION! Caution identify conditions or practices that could result in damaged to the unit or other equipment connected.



WARNING! Before installing and using this inverter, read all instructions and cautionary markings on the inverter and all appropriate sections of this guide.



WARNING! Normally grounded conductors may be ungrounded and energized when a ground fault is indicated.



WARNING! This inverter is heavy. It should be lifted by at least two persons.



CAUTION! Authorized service personnel should reduce the risk of electrical shock by disconnecting both the AC and DC power from the inverter before attempting any maintenance or cleaning or working on any circuits connected to the inverter. Turning off controls will not reduce this risk. Internal capacitors can remain charged for 5 minutes after disconnecting all sources of power.

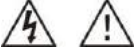

CAUTION! Do not disassemble this inverter yourself. It contains no user-serviceable parts. Attempt to service this inverter yourself may cause a risk of electrical shock or fire and will void the warranty from the manufacturer.



CAUTION! To avoid a risk of fire and electric shock, make sure that existing wiring is in good condition and that the wire is not undersized. Do not operate the Inverter with damaged or substandard wiring.



CAUTION! Under high temperature environment, heat sink of this inverter could be hot enough to cause skin burns if accidentally touched. Ensure that this inverter is away from normal traffic areas.

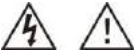

CAUTION! Use only recommended accessories from installer. Otherwise, not-qualified tools may cause a risk of fire, electric shock, or injury to persons.



CAUTION! To reduce risk of fire hazard, do not cover or obstruct the heat sink.



CAUTION! Do not operate the Inverter if it has received a sharp blow, been dropped, or otherwise damaged in any way. If the Inverter is damaged, called for an RMA (Return Material Authorization).

3. Unpacking & Overview

3-1. Packing List

Before installation, please inspect the unit. Be sure that nothing inside the package is damaged. You should have received the following items inside of package:

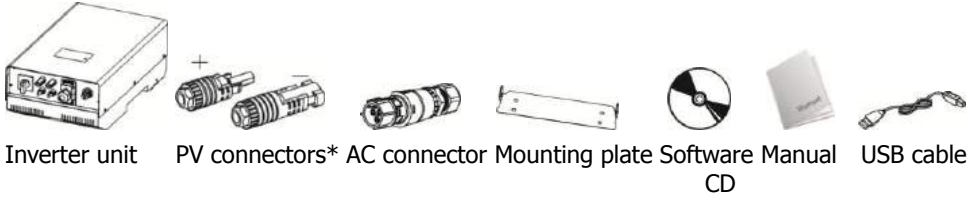

***Note: 1 set of PV connectors for 3KW inverter and two sets of PV connectors for 5KW inverter.**

3-2. Product Overview

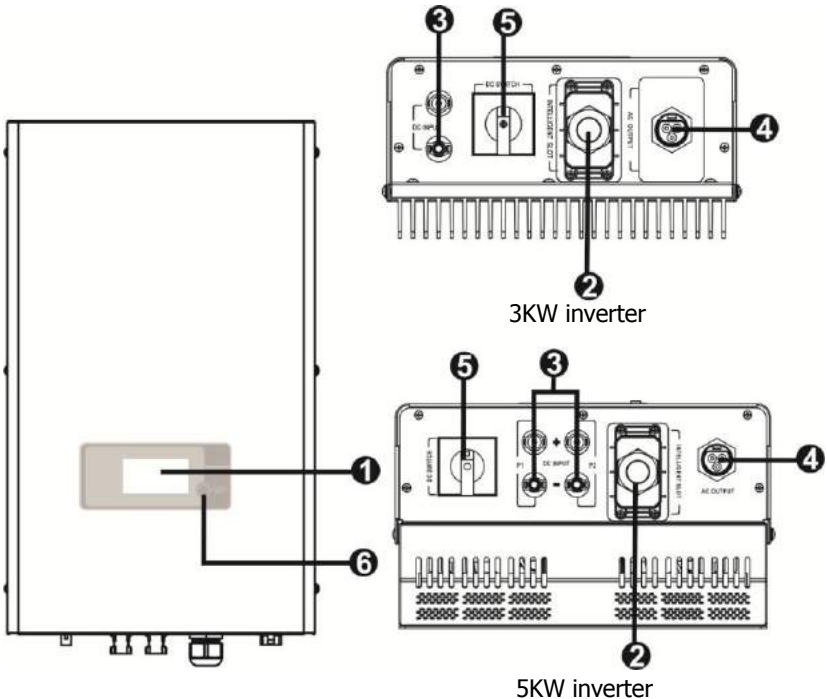

- 1) LCD display panel (Please check section 8 for detailed LCD operation)
- 2) Intelligent slot with USB communication port
- 3) Connectors for solar modules
- 4) AC output terminal
- 5) DC switch (Option)
- 6) Operation button

4. Installation

4-1. Selecting Mounting Location

Consider the following points before selecting where to install:

- Do not mount the inverter on flammable construction materials.
- Mount on a solid surface
- Although the unit is fitted with UV resistant components, direct exposure to sunlight may cause a power reduction due to excessive heating.
- This inverter can make noises during operation which may be perceived as a nuisance in a living area.
- Install this inverter at eye level in order to allow the LCD display to be read at all times.
- For proper air circulation to dissipate heat, allow a clearance of approx. 20 cm to the side and approx. 50 cm above and below the unit.
- Dusty conditions on the unit may impair the performance of this inverter.
- The ambient temperature should be between -25°C and 60°C to ensure optimal operation.
- The recommended installation position is to be adhered to (vertical).
- Unused DC connectors and interfaces must be sealed with sealing plugs to ensure protection class IP65 for the whole system (inverter & cables).
- This inverter is designed with IP65 for outdoor applications with high humidity.

4-2. Mounting Unit with Wall Mounting Bracket

WARNING!! Remember that this inverter is heavy! Please be carefully when lifting out from the package.

Please utilize the delivered mounting plate for problem-free installation of the solar inverter. Installation to the wall should be implemented with the proper screws. Mount the wall bracket so that the solar inverter can be easily attached to the wall. After that, the device should be bolted on securely.

3KW inverter

1. Employ the mounting plate as a template for marking the positions of the boreholes
2. Mount the mounting plate with appropriate screws (M5,SUS304) into four holes to fix the plate in place

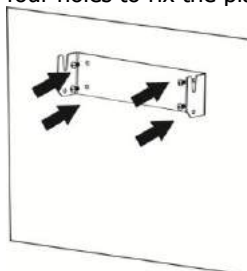
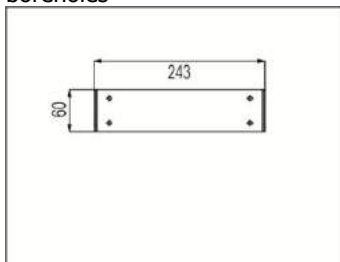

3. Follow the below figure to place the solar inverter onto the mounting plate.
4. Check if the solar inverter is firmly secured.

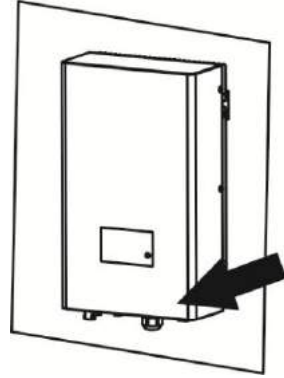
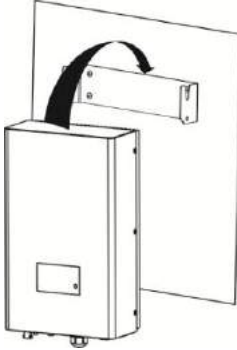

5. Screw the inverter in position by screwing the supplied M5 screw, located on the underside of the enclosure. Refer to blow chart.

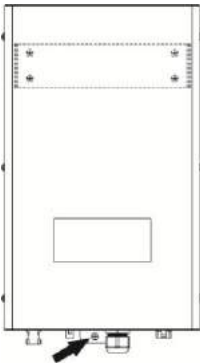

5KW inverter

1. Employ the mounting plate as a template for marking the positions of the boreholes
2. Mount the mounting plate with appropriate screws (M5,SUS304) into four holes to fix the plate in place

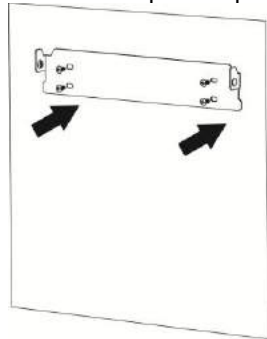
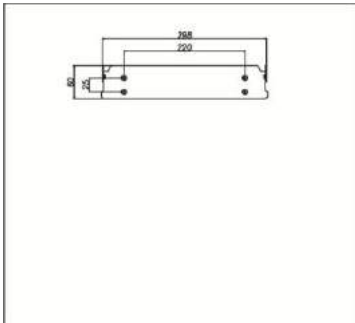

- Follow the below figure to place the solar inverter onto the mounting plate.
- Check if the solar inverter is firmly secured.

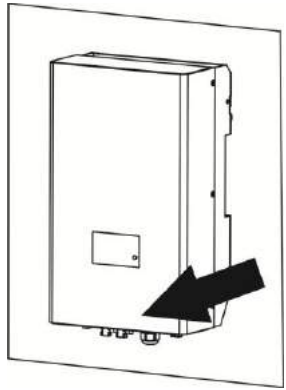
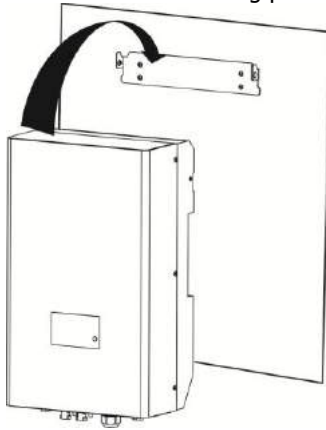

5. Grid (AC) Connection

5-1. Preparation

Before connecting to AC utility, please install a **separate AC** circuit breaker between inverter and AC utility. This will ensure the inverter can be securely disconnected under load.

NOTE1: Although this inverter is equipped with a fuse (F1 point on PCB, 3KW: 250VAC/20A; 5KW: 250VAC/30A), it's still necessary to install a separate circuit breaker for safety consideration. Please use 250VAC/20A circuit breaker for 3KW and 250VAC/30A circuit breaker for 5KW.

NOTE2: If you want to add a manual RCMU, it shall be type B.

WARNING! It's very important for system safety and efficient operation to use appropriate cable for grid connection. To reduce risk of injury, please use the proper recommended cable size as below.

Suggested cable requirement for AC wire

Model	External Diameter(mm)	Conductor cross-section (mm ²)	AWG no.	Temperature
3KW & 5KW	≤4.5	≥3.3	≤12	125°C

5-2. Connecting to the AC Utility

Overview of AC Connection Socket

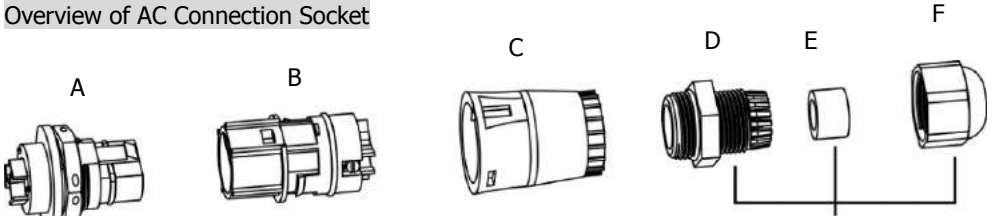

Component	Description
-----------	-------------

Cable gland

A	AC output terminal on the inverter
B	Socket element
C	Protective element
D	Threaded sleeve
E	Sealing nut
F	Pressure dome

Step 1: Check the grid voltage and frequency with an AC voltmeter. It should be the same to "VAC" value on the product label.

Step 2: Turn off the circuit breaker.

Step 3: Insert sealing nut (E) inside of threaded sleeve (D). Then, screw pressure dome (F) tightly onto the assembled threaded sleeve. (Refer to **Chart 1**)

Step 4: Thread the protective element (C) with assembled cable gland over the utility cable. (Refer to **Chart 1**)

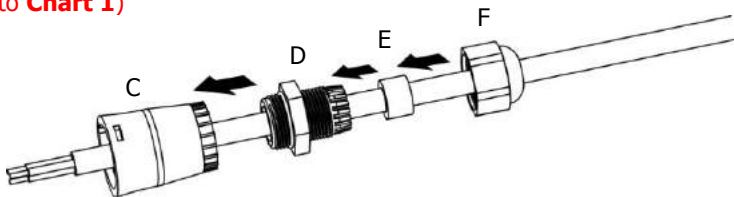
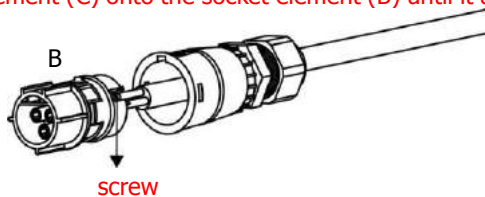

Chart 1

Step 5: Remove insulation sleeve 8 mm for three conductors. And shorten phase L and neutral conductor N 3 mm.



Step 6: Insert utility cable through socket element (B) and tighten the screw to fix utility cable. And push protective element (C) onto the socket element (B) until it audibly snaps into place.



Step 7: Connect wires according to polarities indicated on AC output terminal on the inverter and tighten the screws after connection.

- L**→**LINE** (brown or black)
- G**→**Ground** (yellow-green)
- N**→**Neutral** (blue)

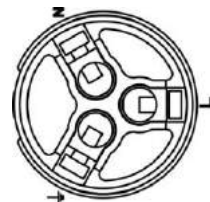

Step 8: Twist the gland so that the cable is firmly connected.

CAUTION: To prevent risk of electric shock, ensure the ground wire is properly earthed before operating the solar inverter.

6. PV Module (DC) Connection

CAUTION: Before connecting to PV modules, please install **separately a 2P circuit breaker for 3KW, 4P or two 2P DC circuit breakers for 5KW** between inverter and PV modules.

NOTE: Please use **600VDC/15A circuit breaker for 3KW and 600VDC/17A circuit breaker for 5KW.**

Please follow below steps to implement PV module connection:

WARNING: This inverter is only compatible to two types of PV modules: single crystalline and poly crystalline. To avoid any malfunction, do not connect any PV modules with possibility of leakage current to the inverter.

Step 1: Assemble provided PV connectors into PV modules by following below steps.

Negative terminal connection

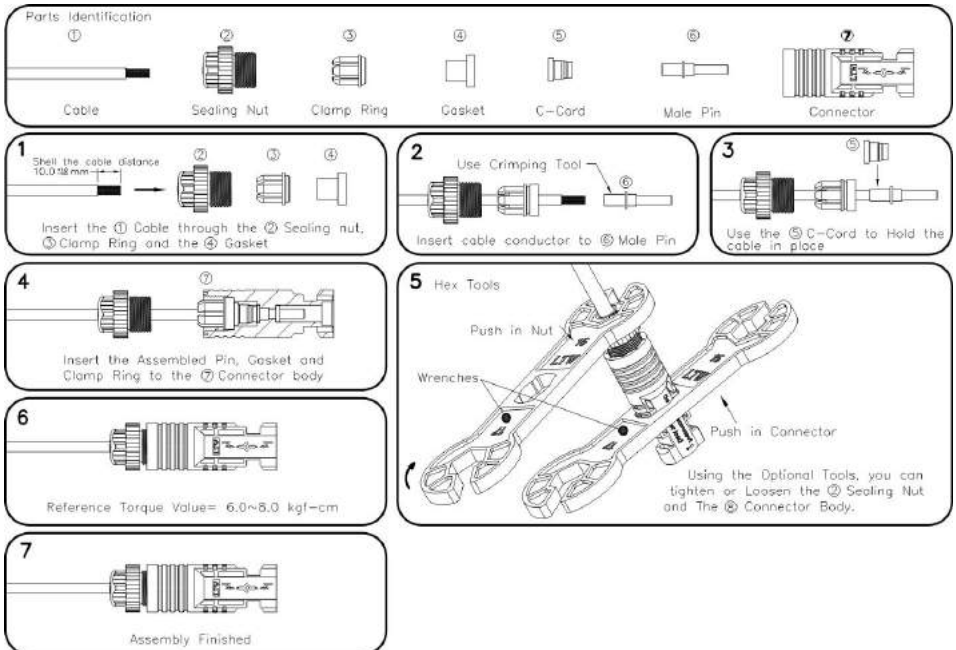

Positive terminal connection

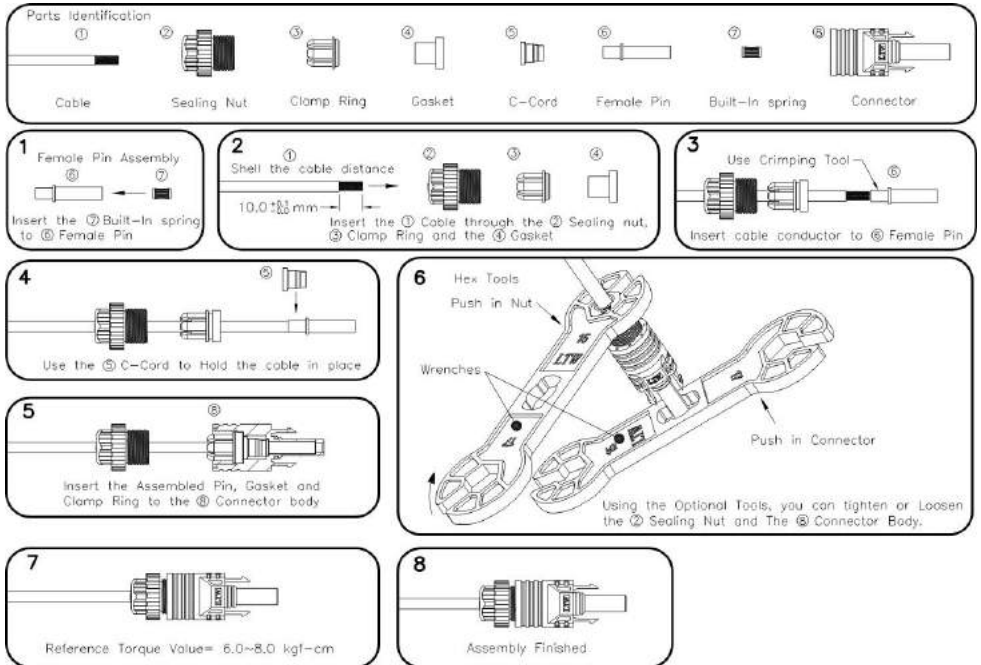

Step 2: Check the input voltage of PV array modules. **The acceptable input voltage of solar inverter is 125VDC - 500VDC.** If this system is only applied with one string of PV array, then please make sure that the maximum current load of each PV input connector is **13A for 3KW and 15A for 5KW.** For 5KW inverter, you may serial connect two sets of PV modules as one and the maximum current load will not exceed 30A.

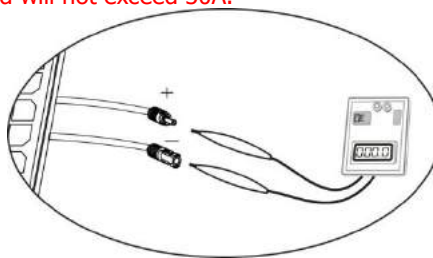

CAUTION: Exceeding the maximum input voltage can destroy the unit!! Check the system before wire connection.

Step 3: Disconnect the circuit breaker.

Step 4: Check correct polarity of connection cable from PV modules and PV input connectors. Then, connect positive pole (+) of connection cable to positive pole (+) of PV input connector. Connect negative pole (-) of connection cable to negative pole (-) of PV input connector.

WARNING! It's very important for system safety and efficient operation to use appropriate cable for grid connection. To reduce risk of injury, please use the proper recommended cable size as below.

Suggested cable requirement for DC wire

Model	External Diameter(mm)	Conductor cross-section (mm ²)	AWG no.	Temperature
3KW & 5KW	≤ 6.0	≥ 3.3	≤ 12	125°C

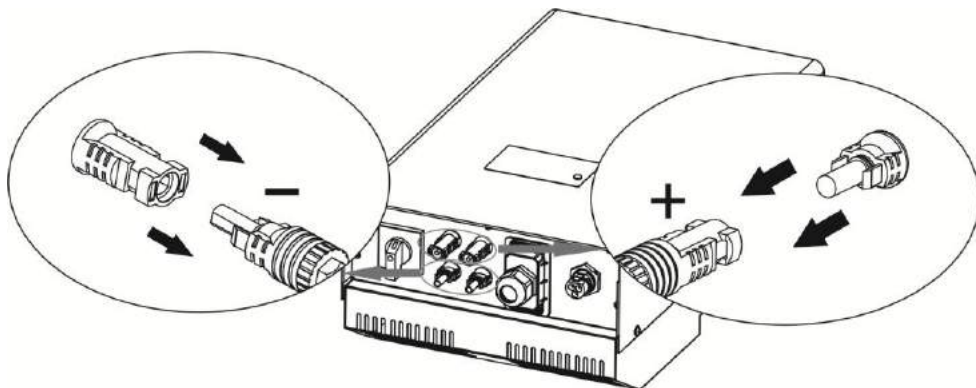

CAUTION: Never directly touch terminals of the inverter. It will cause lethal electric shock.

7. Communication

This inverter is equipped with a slot for communication interfaces in order to communicate with a PC with corresponding software. Follow below procedure to connect communication wiring and install the software.

Step 1: Take out communication cover by removing 4 screws.

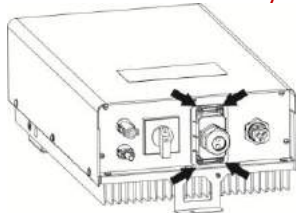

Step 2: There are two kinds of ports available: RS-232 and USB. You may use supplied USB cable to connect USB port of this inverter and your PC. Or you may use one network cable (RJ-45) to connect RS-232 port of this inverter and your PC.

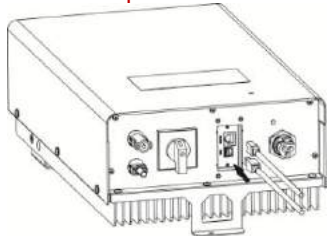

Step 3: Install monitoring software in your PC. For the details of monitoring software, please check with the installer.

Step 4: Initial your monitoring software and extract data through communication port. After completing data acquisition, please put the communication port back to the unit.

8. Commissioning



Step 1: Check the following requirements before commissioning:

- Ensure the inverter is firmly secured
- Check if the open circuit DC voltage of PV module meets requirement (Refer to Section 6)
- Check if the open circuit utility voltage of the utility is at approximately same to the nominal expected value from local utility company.
- Correct connection to grid
- Full connection to PV modules
- Unused DC input connectors are sealed with supplied sealing plugs.
- AC circuit breaker and DC circuit breaker are installed correctly.

Step 2: After switching on the DC circuit breakers, it will display "No Utility" in the LCD screen. Then, switch on the AC circuit breakers. After **60 seconds**, the system will automatically connect to the grid. Then:

- If inverter icon is in the LCD display like below, commissioning has been successfully.



- Or, if  icon flashes, there is insufficient radiation and the inverter is in standby mode. Wait for sufficient radiation.
- Or, if  icon flashes, the grid voltage or frequency is beyond acceptable range and the inverter is in standby mode. Wait for grid voltage or frequency to return to acceptable range.
- Or if **ERROR** icon flashes, there has been an error. Please check chapter 10 for trouble shooting. If the problem still resists, please inform your installer.

9. Operation

9-1. Interface





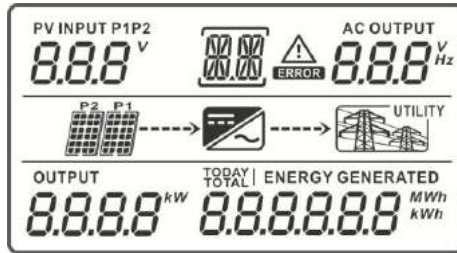

This LCD panel shows current status and value of your system. This display is operated by Information/SELECT button.

NOTICE: To accurately monitor and calculate the energy generation, please calibrate the timer of this unit via software every one month. For the detailed calibration, please check the user manual of bundled software.

9-2. LCD Information Define



Display	Function
PV INPUT P1P2 	Indicates input voltage of PV module 1 or PV module 2. P1: PV module 1, P2: PV module 2, V: voltage
AC OUTPUT 	Indicates AC output voltage or frequency. V: voltage, Hz: frequency
OUTPUT 	Indicates current feeding power.
TODAY ENERGY GENERATED 	Indicates energy generated today.
TOTAL ENERGY GENERATED 	Indicates total energy generated so far.
	Indicates that the warning occurs.
ERROR	Indicates that the fault occurs.
	Indicates fault code in fault mode or WR for warning situation.
	Indicates PV module status. <ul style="list-style-type: none"> Each indicates 150VDC. When input voltage is

	below 100VDC,  icon will flash.
	<ul style="list-style-type: none"> When PV module is not connected,  icon will flash.
	Indicates the Inverter circuit is working.
	Indicates grid.

9-3. Operation Button

The INFORMATION/SELECT button controls LCD settings and has three functions.

Function	Operation	Description
Information changes	Press the button once	To jump to next selection or decrease value.
Query Menu	Press and hold the button for 2 seconds	To enter query menu
Selection confirmed	Press and hold the button for 2 seconds	To confirm selection or value entry in query menu.

NOTE: If backlight shuts off, you may activate it by pressing any button.

9-4 Query Menu Operation

This display shows current values of your system. These displayed values can be changed in query menu via button operation. Press "INFORMATION/SELECT" button to enter query menu. There are three query selections:

- Input voltage of PV module 1 or PV module 2
- Frequency or voltage of AC output
- Power generation today or total power generation since installation.

Input voltage of PV module

Input voltage of PV module 1

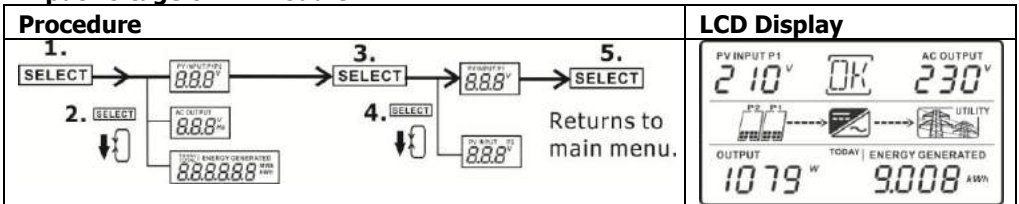

Input voltage of PV module 2 (only available for 5KW)

Procedure	LCD Display
<p>1. SELECT → PV INPUT P2 8.88^v</p> <p>2. SELECT ↓ AC OUTPUT 8.88^v / TODAY ENERGY GENERATED 8.88888 kWh</p> <p>3. SELECT → PV INPUT P2 8.88^v</p> <p>4. SELECT ↓ PV INPUT P2 8.88^v</p> <p>5. SELECT → Returns to main menu.</p>	

Frequency or voltage of AC output

Voltage of AC output

Procedure	LCD Display
<p>1. SELECT → PV INPUT P1 8.88^v</p> <p>2. SELECT ↓ AC OUTPUT 8.88^v / TODAY ENERGY GENERATED 8.88888 kWh</p> <p>3. SELECT → AC OUTPUT 8.88^v</p> <p>4. SELECT ↓ AC OUTPUT 8.88^v</p> <p>5. SELECT → Returns to main menu.</p>	

Frequency of AC output

Procedure	LCD Display
<p>1. SELECT → PV INPUT P1 8.88^v</p> <p>2. SELECT ↓ AC OUTPUT 8.88^{Hz} / TODAY ENERGY GENERATED 8.88888 kWh</p> <p>3. SELECT → AC OUTPUT 8.88^{Hz}</p> <p>4. SELECT ↓ AC OUTPUT 8.88^{Hz}</p> <p>5. SELECT → Returns to main menu.</p>	

Power generation

Power generation today

Procedure	LCD Display
<p>1. SELECT → PV INPUT P1 8.88^v</p> <p>2. SELECT ↓ AC OUTPUT 8.88^{Hz} / TODAY ENERGY GENERATED 8.88888 kWh</p> <p>3. SELECT → TODAY ENERGY GENERATED 8.88888 kWh</p> <p>4. SELECT ↓ TODAY ENERGY GENERATED 8.88888 kWh</p> <p>5. SELECT → Returns to main menu.</p>	

Total power generation since installation

Procedure	LCD Display
<p>1. </p> <p>2. </p> <p>3. </p> <p>4. </p> <p>5. </p> <p>Returns to main menu.</p>	

9-5. Operation Mode & Display

Mode	LCD Display	Description
Power on mode		The inverter is initializing.
Grid mode		The inverter is feeding power to the grid.
Standby mode		The inverter is waiting for the DC voltage to reach a certain level so that it can start feeding the grid.
Fault mode	<p> and icons will flash.</p>	An error occurs inside of the inverter. Please inform your installer.

10. Maintenance & Cleaning

Check the following points to ensure proper operation of whole solar system at regular intervals.

- Heat sink of the inverter should be cleaned from dust.
WARNING: Although the inverter is designed in sealed IP65 enclosure, it is not recommended to use a pressure washer to clean the inverter, or use other high pressure cleaning methods that could allow water or moisture to enter the unit.
- Clean the PV modules, during the cool time of the day, whenever it is visibly dirty.
- Periodically inspect the system to make sure that all wires and supports are securely fastened in place.

WARNING: There are no user-replaceable parts inside of the inverter. Do not attempt to service the unit yourself.

11. Trouble Shooting

When there is no information displayed in the LCD, please check if PV module connection is correctly connected.

11-1. Warning Situation







There are 4 situations defined as warnings. When a warning situation occurs,  icon will flash and the fault code area will display "WR" wordings.

No PV module is connected	flash failure
Inverter initial failure	Fan failure (Only for 5KW)

11-2. Fault Reference Codes

When a fault occurs, the icon  will flash as a reminder. See below for fault codes for reference.

Note: When the fault occurs, it will be recorded in the flash, Max 9 faults can be saved. You can use Solar Power to read the fault data log. The detail information please refer to Solar Power Manual 4.3.3.

Situation			Solution
Fault Code	Fault Event	Icon (flashing)	
1	Over voltage on Bus		1. Disconnect AC circuit breaker first. Then, disconnect DC circuit breaker. 2. Until LCD screen completely shuts down, turn on DC breaker first. It will show "No Utility" in LCD screen. Then, turn on AC breaker. After 60 seconds, the system will
2	Under voltage on Bus		
3	Time out for Bus soft start		
4	Time out for Inverter soft start		
5	Inverter over current		
7	Relay or inverter voltage detector fault		
8	Output current sensor		

	failure		
10	Power failure	ERROR	3. If the error message still remains, please contact your installer.
11	DC input over current	ERROR	
14	Inverter DC current over	ERROR	
16	GFCI sensor failure	ERROR	
6	Over temperature	ERROR	<ol style="list-style-type: none"> 1. The internal temperature is higher than specified temperature. 2. Leave inverter to be cooled to room temperature. 3. If the error message still remains, please contact your installer.
9	High voltage on PV module	ERROR	<ol style="list-style-type: none"> 1. Check if the open circuit voltage of PV modules is higher than 500VDC. 2. If PV open circuit voltage is less than 500VDC and the error message remains, please contact your installer.
12	GFCI failure	ERROR	<ol style="list-style-type: none"> 1. The ground voltage is too high. 2. Please disconnect AC breaker first and then DC breaker. Check if grounding is connected properly after LCD screen completely shuts down. 3. If grounding is correctly connected, turn on DC breaker. After it displays "No Utility" in LCD screen, turn on AC breaker. After 60 seconds, the system will automatically connect to the grid. 4. If the error message still remains, please contact your installer.
13	PV insulation failure	ERROR	<ol style="list-style-type: none"> 1. Check if the impedance between positive and negative poles to the ground is greater than 1MΩ. 2. If the impedance is lower than 1MΩ, please contact

			your installer.
15	Line value consistent fail between MCU & DSP	ERROR	<ol style="list-style-type: none"> 1. Please disconnect AC breaker first and then disconnect DC breaker. 2. After LCD screen is completely off, turn on DC breaker. Until it shows "No Utility" in LCD display, turn on AC breaker. After 60 seconds, the system will automatically connect to the grid. 3. If error message remains, please contact your installer.
17	Connection failure between MCU & DSP	ERROR	
18	Communication failure between MCU & DSP	ERROR	
19	Ground loss	ERROR	<ol style="list-style-type: none"> 1. Check if the inverter is connected to the ground. 2. If ground is properly connected and the error message remains, please contact your installer.
22	Grid voltage loss	ERROR	<ol style="list-style-type: none"> 1. Grid loss is detected or grid input is not within acceptable range. 2. If grid is ok but the error still remains, please contact your installer.
23	Grid frequency loss	ERROR	
24	Islanding is detected.	ERROR	Grid is abnormal. Please wait for grid to return.
No display in LCD screen.			<ol style="list-style-type: none"> 1. Check input voltage of PV modules. 2. If input voltage is higher than 150VDC, please contact your installer.
Time display in LCD screen changes quickly or slowly.			<ol style="list-style-type: none"> 1. Please calibrate the timer via software. 2. If the problem remains after calibration, please contact your installer.
Inverter is turned on and turned off in turns.			<ol style="list-style-type: none"> 1. It's normal situation due to insufficient radiation in the short-term time.

12. Specifications

MODEL	PV Inverter 3KW	PV Inverter 5KW
INPUT (DC)		
Max. DC Power	3300 W	5000W
Maximum DC Voltage	500 VDC	
MPP Voltage Range	250 VDC ~ 500 VDC	180 VDC ~ 500 VDC
DC Nominal Voltage	370 VDC	
Start-up Voltage / Initial Feeding Voltage	125VDC / 150VDC	
Maximum Input Current	1 x 13 A	2 x 15 A
Number of MPP Trackers / Strings per MPP Tracker	1 / A: 1	2 / A: 1; B: 1
OUTPUT (AC)		
AC Nominal Power	3000 W	4600 W
Maximum AC Apparent Power	3000 VA	4600 VA
Nominal AC Voltage / Range**	230 VAC / 184 VAC ~ 264 VAC	
AC Grid Frequency	50 Hz / 60 Hz	
AC Grid Frequency Range**	47.5~ 51.5 Hz	
Nominal Output Current	13A	20 A
Power Factor @ > 50% load	> 0.99	
EFFICIENCY		
Maximum Efficiency @ Nominal Voltage	97.3%	97.3%
European Efficiency @ Nominal Voltage	96.4%	96.7%
PROTECTION		
DC Reverse-Polarity Protection	Yes	Yes
Ground Fault Monitoring	Yes	Yes
Grid Monitoring	Yes	Yes
AC Short Circuit Protection	Yes	Yes
Over Current Protection	30 A	50 A
Inrush Current	17 A / 1s	25 A / 1s
Maximum Output Fault Current	60 A / 10ms	100 A / 10ms
PHYSICAL		
Dimension, D X W X H (mm)	450 x 270 x 160	515 x 308 x 182
Net Weight (kgs)	15	20
INTERACE		
Intelligent Slot	USB & RS-232 card / Optional SNMP & Modbus card	
ENVIRONMENT		
Protection Degree	IP65/Pollution Degree III	
Humidity	0 ~ 100%	
Operating Temperature	-25°C to 60°C*	
Altitude	0 ~ 1000 m	

* When temperature is above 80°C, the unit will de-rate according to the below formula:

$$P=P_{Rating} \times [110\%-(T-80)\times 10\%].$$

** The grid voltage and frequency range can be changed through SolarPower software. Please check software manual for the details. But it needs electric power carrier permission. Customers don't have authority to do so.